

Air Sniper Induct 300W BAS compatible

Instruction Manual





A WORD TO AIR SNIPER OWNERS

At Air Sniper, we design and build air supplemental sanitization systems with complete customer satisfaction in mind. To ensure trouble-free operation of your supplemental air sanitization system, please read this manual and follow installation recommendations.

An authorized Air Sniper representative will know the system best, and if service or maintenance is needed, the Air Sniper team is here to help. Our team provides you with the best possible service and ensuring your satisfaction with our product.

For inquiries, questions or concerns regarding the unit, or any other Air Sniper products contact:



1.866.472.1059

info@airsniper.ca

Air Sniper Bay 11

6565 40th Street S.E.

Calgary, AB Canada T2C 2J9

Call, email or fill out the online form and one of our customer service specialists will get in touch with you.

© AIR ALPINE INNOVATIVE RESEARCH INC. All rights reserved. This document is subject to change without notice.

All Air Sniper trademarks and logos are owned by Air Sniper or one of its affiliates. Unless expressly noted, names and brands of third parties that may be used in this document are not used to indicate an affiliation or endorsement between the owners of these names and brands and AIR ALPINE INNOVATIVE RESEARCH INC. Those names and brands may be the trademarks or registered trademarks of those third parties. Because we are continuously improving our products and services, Air Sniper reserves the right to change specifications without prior notice. Air Sniper is an equal opportunity employer.



IMPORTANT SAFETY INSTRUCTIONS

WARNING: NEVER EXPOSE SKIN OR EYES TO UV LAMP WHEN OPERATING

Read and follow all instructions prior to installation. Read the directions and all safety labels prior to operation. Failure to follow any instructions or labels may result in injury of the user or damage to the unit. Save this manual for future reference.

1. The Induct BAS compatible unit is intended to be used for supplemental air sanitization inside of a sealed air chamber. **Do not** attempt to operate the UV-C lamps outside of the sealed housing.
2. Electrical shock may cause Injury or possible death. Ensure that the unit is turned off and disconnected from the power source prior to installation or replacement.
3. Untrained personnel can perform installation and replacement of the unit as per the instructions within this manual. **Do not** attempt to perform any maintenance on your unit. Improper maintenance can result in damage to the unit and injury of the user. If your unit requires maintenance, please contact Air Sniper. Replacement of the UV-C lamp by the user is **not allowed**.
4. **Do not** attempt to modify your unit. Modification of this unit may result in injuries to the user or damage to the unit.
5. Inspect your unit for any abnormalities or damage prior to installation and use. Damaged units can result in harmful UV-C leaks. **Do not** operate units that are damaged.
6. If the supply cord is damaged, it must be replaced by the manufacturer, a service agent or similarly qualified persons in order to avoid a hazard.
7. This appliance contains a UV-C emitter. UV-C lamps contain small amounts of mercury. If the lamp is broken or damaged, clean and dispose of it properly as per your local safety regulations.
8. The Induct BAS compatible unit is not to be used by persons (including children) with reduced physical, sensory or mental capabilities, or a lack of experience and knowledge, unless properly supervised. Children shall be supervised so that they do not to play with the unit.
9. It is recommended a minimum of 2 people are present when installing the unit. Units can be heavy and require care and precision when installing.
10. Air Sniper products are not waterproof. **Do not** attempt to use your unit in a wet environment.
11. Air Sniper products are designed for indoor use only. **Do not** attempt to install your unit outdoors.
12. The use of this device is a supplement to and not a substitute for standard infection control practices; users must continue to follow all current infection control practices related to cleaning and disinfection of environmental surfaces.
13. The Induct BAS compatible unit does not require cleaning to continue to operate effectively.
14. **FIRST AID INSTRUCTIONS:** If Injury occurs, contact your doctor or appropriate emergency services.
15. **WARNING: UV RADIATION EMITTED FROM THIS DEVICE.** Unintended use of the appliance or damage to the housing may result in the escape of dangerous UV-C radiation. UV-C radiation may, even in small doses, cause harm to the skin and eyes

Air Sniper Induct 300W BAS compatible



FEATURES

No Ozone (UL 2998 Certified, CARB certified)

6+ Year Lamp Life (55, 200 Hours)

BAS Compatible

300 Watt Bulb

5-Year Warranty

SPECIFICATIONS

Available Power Requirements:	208-240 VAC, Single Phase, 60 Hz
Energy Consumption:	1.8 Amp Max (420 Watt) @208 VAC
Weight:	15 lbs (7 kg)
Power Control:	Status, Lamp life, Alarm Indicators
Housing Material:	Aluminum
Dimensions:	25" (H) x 10" (W) x 5.36" (D)
Electrical Safety Certification:	cETLus Certified, UL and CSA Standards
Airflow Detection:	Differential Pressure Switch
Operating Temp Range:	-20C/+100C
Recommended Airflow:	500-7,500 CFM
Connection Power Control:	Single or daisy chain 15-30 VAC/10-20 VAC



Air Sniper Induct 300W BAS compatible



FEATURES

No Ozone (UL 2998 Certified, CARB certified)

6+ Year Lamp Life (55, 200 Hours)

BAS Compatible

300 Watt Bulb

5-Year Warranty

SPECIFICATIONS

Available Power Requirements:	110V VAC, Single Phase, 60 Hz
Energy Consumption:	3.5 Amp Max (420 Watt) @110V VAC
Weight:	15 lbs (7 kg)
Power Control:	Status, Lamp life, Alarm Indicators
Housing Material:	Aluminum
Dimensions:	25" (H) x 10" (W) x 5.36" (D)
Electrical Safety Certification:	cETLus Certified, UL and CSA Standards
Airflow Detection:	Differential Pressure Switch
Operating Temp Range:	-20C/+100C
Recommended Airflow:	500-7,500 CFM
Connection Power Control:	Single or daisy chain 15-30 VAC/10-20 VAC





DETAIL DRAWINGS

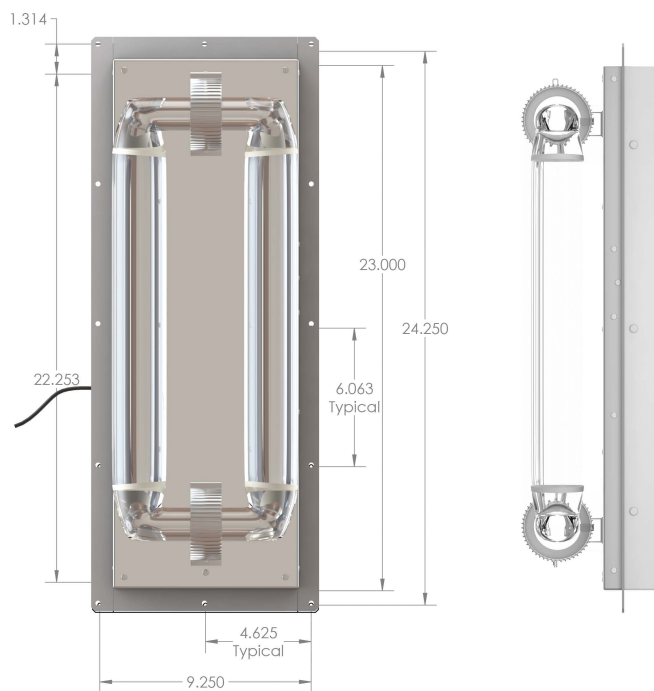



ABOUT YOUR UNIT

For more information on the Induct BAS compatible unit and all other Air Sniper products and services, call (Toll Free) **1-888-338-9549**, visit www.airsniper.ca or email Air Sniper at **info@airsniper.ca** with any questions, comments or concerns.

DESIGN

The Induct BAS compatible unit is made up of several key components listed below.



- 1. 300W UVC Lamp
- 2. Power Port
- 3. Daisy Chain Connections
- 4. LED Indicators



FEATURES

- 300 Watt UV-C Induction Lamp
- 6+ Year Lamp Life (55,200 Hours)
- BAS Compatible
- UL 2998 Certified
- No maintenance
- Canadian Made

SPECIFICATIONS

Power Supply

(depending on Model purchased)

Single Phase, 110V A/C 50/60 Hz

Or

Single Phase, 208V – 240V A/C 50/60 Hz

Energy Consumption

1.8 Amp Max @ 208V A/C

3.5 Amp Max @110V A/C

Operating Temperature Range

-25°C / 100°C

Power Control Systems

(depending on Model purchased)

On/Off Switch, Single or Daisy Chain

15-30v AC / 10-120v AC

Bulb Life

55,200 hours (6+ years) of high intensity UVC.

Electrical Safety Certification

cETLus Certified, UL & CSA Standards

Ozone Certification

UL2998 certified. CARB Certified.

Weight

15 lbs (7.0 kg)

Dimensions

25" (H) x 10" (W) x 5.36" (D)

Housing Material

Aluminum



RECOMMENDED LINE CONDITIONER SPECIFICATIONS

Line conditioner required to prevent damage. To prevent damage and ensure warranty coverage please ensure line conditioners are on all AC inputs to protect equipment from voltage spikes. If a line conditioner is not installed your Warranty may not be valid.

Please see below for recommended line conditioner specifications. Line conditioners can be purchased online or through a local building supply store.

Surge Protection Device - Surge Protective Device, 3-Mode, 120/240 VAC 1Ph, Type 1 or Type 2, Outdoor, Connected Equipment Warranty 3yr \$7,500

Item AG3000



PRODUCT DESCRIPTION

Power surges are the silent killer for home appliances and HVAC equipment. Most homeowners protect their electronics, but leave more valued equipment unprotected. Surges can wipe out equipment and leave you searching for answers. Search no more. The easy-to-install AG3000 Surge Protective Device (SPD) is the perfect add-on for HVAC equipment. A green LED indicator provides the status of protection. Trusted, state-of-the-art TPMOV® (Thermally Protected Metal Oxide Varistor) technology eliminates the potentially hazardous failure modes that are commonly associated with standard MOV technology. UL Listed to ANSI/UL 1449, 4th Edition.

FEATURES

- ▶ Three modes of protection: L-G, L-L, L-N
- ▶ TPMOV® surge protection technology
- ▶ Green LED indicator provides status of protection
- ▶ Type 4X watertight and UV resistant plastic enclosure
- ▶ 3-year product warranty
- ▶ \$7,500 connected equipment warranty for 3 years
- ▶ UL Listed to ANSI/UL 1449 5th edition

APPLICATIONS

- ▶ Distribution Panel
- ▶ Service Entrance
- ▶ HVAC Equipment Protection

TECHNICAL DATA

General	
Model Number	AG3000
Description	Surge Protective Device, 3-Mode, 120/240 VAC 1Ph, Type 1 or Type 2, Outdoor, Connected Equipment Warranty 3yr \$7,500
UPC Code	078275130678
Brand	Intermatic
Country of Origin (Intermatic)	MEXICO
Warranty Period	3-Year limited
Connected Equipment Warranty Period	3-Year limited
Connected Equipment Warranty Coverage (USD)	7500

Electrical Specifications	
Modes of Protection	3 (L1-N, L2-N, L1-L2)



Electrical Specifications

Modes of Protection	3 (L1-N, L2-N, L1-L2)
Short Circuit Current Rating	100 kA
Nominal Discharge Current	20 kA
Maximum Surge Current Rating Per Phase	50 kA
Surge Protection Technology	TPMOV®
Maximum Continuous Operating Voltage (L-G)	150
Maximum Continuous Operating Voltage (L-L)	300
Maximum Continuous Operating Voltage (L1-N/G)	150
Voltage Protection Rating (L-L)	1200
Voltage Protection Rating (L1-N/G)	700
Phase	Single

Control Specifications

Undervoltage Pickup [120 VAC] (VAC)	104
Undervoltage Pickup [208 VAC] (VAC)	180
Undervoltage Pickup [240 VAC] (VAC)	208
Surge Protection Type	1; 2
Surge Protection LED Indicator	Green

Mechanical Specifications

Number of Wire Leads	3
Enclosure Type	Indoor/outdoor type 4X

Dimensions

Product Dimensions (H x W x D) in	3.875 x 1.625 x 4.188 in
Wire Lead Length (in)	18
Wire Size Max	#10 AWG, Tinned Copper



INCLUDED PARTS

Included in the package you will find:

- 1. Induct BAS compatible
- 2. Power Connection Cord
- 3. 4 x **optional** Magnetic Lined Reflective Panels (22 3/4" x 8" each)
- 4. (12) - #8 Tek Screws





INSTALLING YOUR UNIT

CAUTION: Use care when unboxing and handling your unit. Ensure adequate space is available for unboxing, installation, and operation prior to attempting to handle your unit. Ensure that the intended placement of your unit allows access to the necessary power requirements and does not create a hazard once connected.

Line conditioner required to prevent damage. To prevent damage and ensure warranty coverage please ensure line conditioners are on all AC inputs to protect equipment from voltage spikes. If a line conditioner is not installed your Warranty may not be valid.

Please see below for recommended line conditioner specifications. Line conditioners can be purchased online or through a local building supply store

REQUIRED TOOLS

- Drill for Tek screws
- Drill bit to initiate cut-out puncture.
- Sheet metal tin snips or appropriate cutting equipment
- (12) - #8 Tek screws

INSTALLATION

To Install the Induct BAS compatible unit:

1. Remove from packaging

- a. Carefully remove your Induct BAS compatible, Power Port Connection Cord, (12) - #8 Tek screws and reflective panels from the shipping box.
- b. Inspect the unit and all components, make note of any damage or defects that may have occurred during shipment.

If after opening your unit you notice any missing or damaged components, please contact your Air Sniper representative for immediate assistance.

(Toll Free) 1.888.338.9549

www.airsniper.ca



2. Prepare location for installation

- c. Determine the best location to install your unit. Both return and supply duct locations are acceptable for installation. Return air installation can assist with coil cleaning. For more information on best locations for your unit, consult the installation parameters in this manual or contact Air Sniper.
- d. Once an installation location has been determined, take note of the direction of airflow within the duct, In order to maximize effectiveness, make sure to mount the unit accordingly.

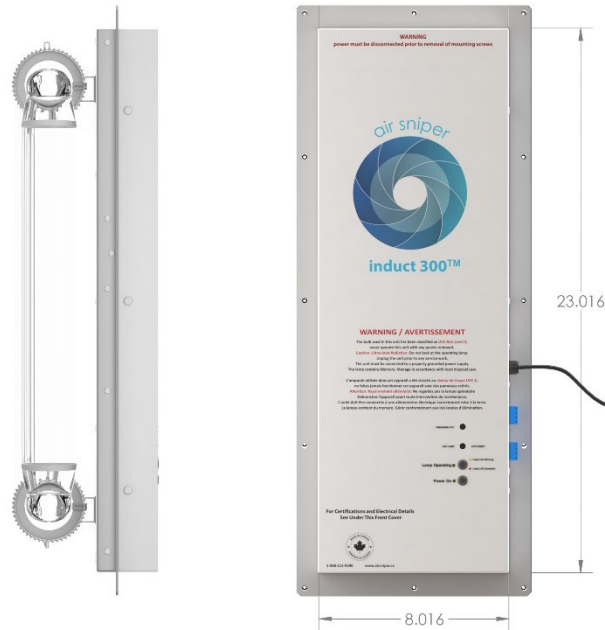

- e. Turn off all HVAC equipment prior to installation. Ensure that all exterior insulation of the HVAC duct is cut 2" back from the point of installation.
- f. Using one of the **optional** reflective panels as a template, identify and mark the intended cut out location for mounting the unit and trace the panel where the unit will be installed. Traced rectangle should have the following dimensions: 22 ¾" x 8"





4. Cutting into the duct

- a. Drill a hole on one of the corners of your traced outline using it as a starting point to cut out the opening in the duct for the unit to be installed. Ensure that the drill hole is made within the perimeter traced as to not leave a gap once the unit is installed.

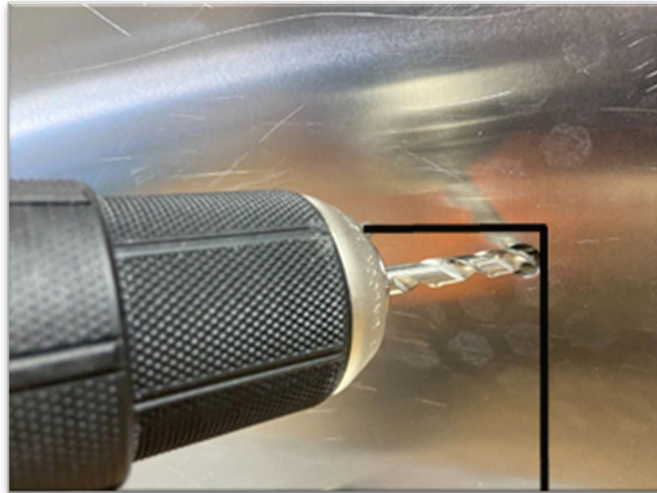

- b. Using the sheet metal snips (or other appropriate cutting device), carefully follow the trace, slowly cutting the opening where the unit is to be installed.





3. Placing Optional reflective panels

- a. If using panels, remove blue protective plastic film from the provided magnetic reflective panel.



- b. Carefully place the unit through the cut-out in the duct work
- c. Using your drill, the (12) #8 Tek screws and the pre-drilled mounting holes, secure the unit into the pre-cut duct work
- d. **Due to the thickness of ducts or imperfections foil HVAC tape may be required to prevent light leakage on the cut lines.**



Reminder: When mounting, it is strongly recommended to consider a scheme that allows easy access for maintenance and unit replacement.

DIRECTIONS FOR USE



To operate your Induct BAS compatible unit,

1. Use the following diagram to connect power to your unit. If multiple units are used, this diagram below illustrates how to daisy chain multiple units together.

The wiring of the Induct BAS compatible unit as a part of a facilities BACnet protocol is done simply by wiring the units in a series as shown in the above image. It is important to maintain that each wire is routed to the correct location in each port.

For more information regarding BAS wiring, or any other BAS features please call **1-888-338-9549** to speak to one of our representatives, or email Air Sniper at info@airsniper.ca with any questions that you may have.

BAS Compatible Induct 300W - 110V/208V Daisy Chain Wiring Detail Up to a six unit system configuration

This detail is for connecting up to six units to a BAS system. If less than 6 units are in the system the Pin 1 and 2 out configuration on Unit 6 will be the configuration of the last unit in system.

The Bulb Status and Remote NC Sensor lines are continuity circuits only. If the internal circuit board senses a bulb failure the circuit board opens a dry contact. The lack of continuity in the line to be sensed by the BAS system to trigger a fault indication. If internal circuit board senses an open contact on the Remote NC Sensor Line it will disconnect the lamp(s). This will trigger bulb failure on the BAS system as well. These circuits can use any light gauge signal wire. No current is present.

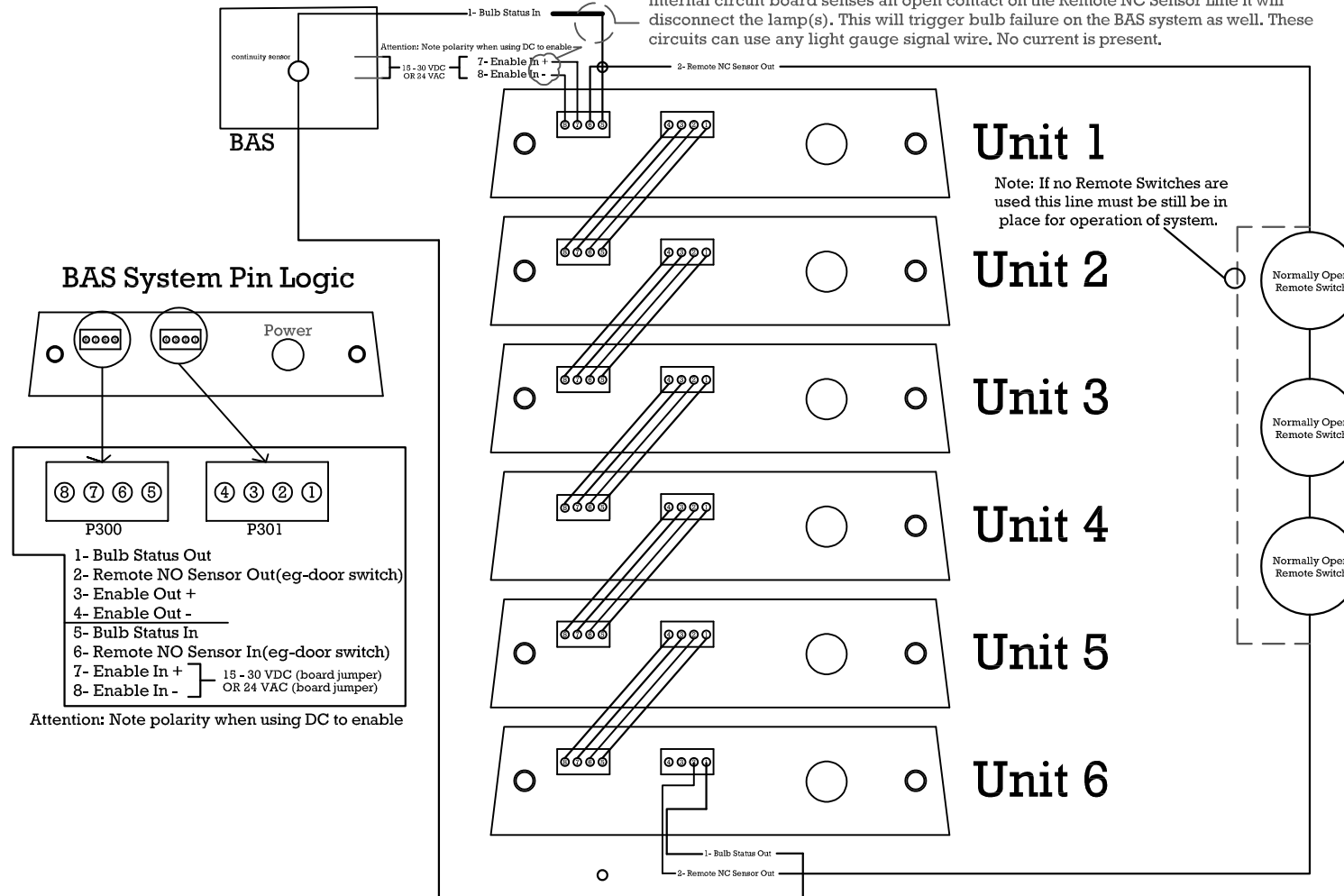

REVISIONS				
REV.	DESCRIPTION	DATE	BY	APPROVED

MATERIAL	
FINISH	

DIMENSIONS IN mm (INCHES)	
TOLERANCES ARE:	
DISTANCE:	
0 - 50	→ ± 0.1 (0.0041)
50 - 150	→ ± 0.5 (0.020)
150+	→ ± 1.0 (0.040)
ANGLES:	→ ± 0.5°
FRACTIONS:	→ ± 1/32

CAD GENERATED DRAWING	
DO NOT MANUALLY UPDATE	
ORIGINATING ECR #	N/A
APPROVALS	DATE
DRAWN Bernard D	16/10/19
CHECKED	
PRODUCT	

AIR	
Alpine Innovative Research	
DWG Description	
Induct 300 BAS Compatible Connection Schematics	
PART. NO.	REV.
SCALE 1:1	SHEET 1 OF 1

THE INFORMATION CONTAINED IN THIS DRAWING IS THE SOLE PROPERTY OF ALPINE INNOVATIVE RESEARCH. ANY REPRODUCTION IN WHOLE OR IN PART WITHOUT THE WRITTEN PERMISSION OF ALPINE INNOVATIVE RESEARCH IS PROHIBITED.



To Operate your Induct 300 unit,

1. Turn off the supplied power and wire the 10' power cord to the desired power source.

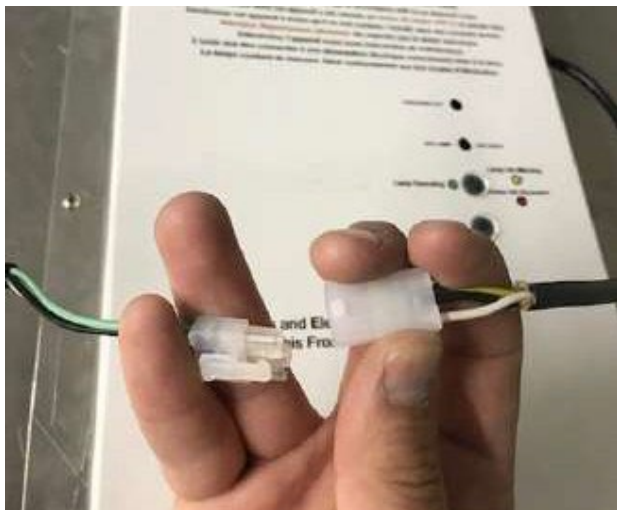

2. The **“Power On”** LED should illuminate, if not turn the unit back off and inspect the cable connections to verify the unit is properly connected.
 - g. If all the connections are correct and the outlet is tested to verify the unit is receiving power but the **“Power On”** LED still isn't illuminated, turn your unit off and contact an Air Sniper representative.

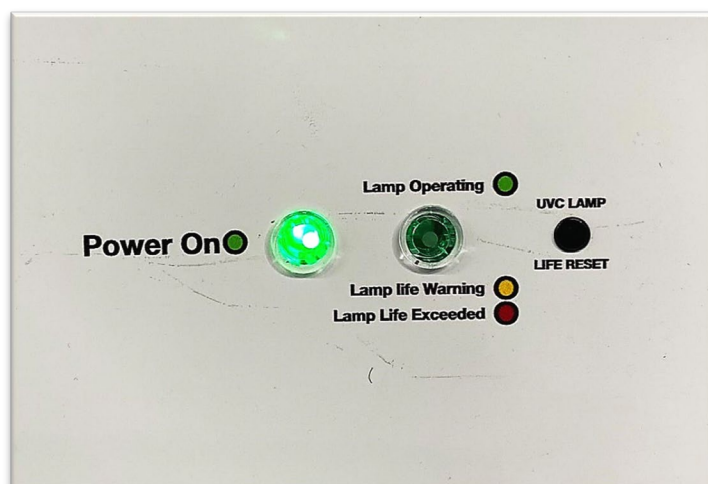



- Once power is detected, the “**Lamp Operating**” LED will illuminate, indicating the UVC Lamp is on.

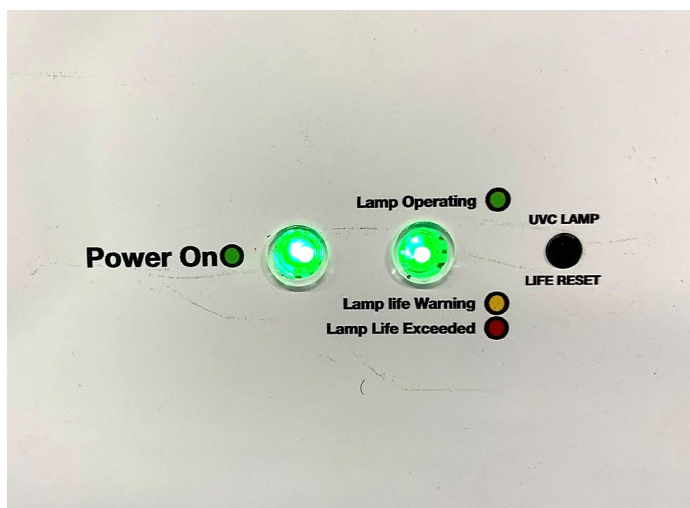

BULB STATUS

The “**Lamp Operating**” LED can illuminate three different colors, indicating differing bulb status.

The variations are as follows:

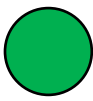
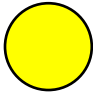
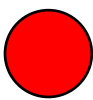
	Green: Lamp operating, the lamp is operating as intended.
	Yellow: Lamp life warning, the lamp is nearing the end of its lifespan, requires replacement in the near future.
	Red: Lamp life exceeded, lamp has reached the end of its lifespan, requires immediate replacement.

When the “**Lamp Operating**” LED color is **yellow** indicating “**Lamp Life Warning**” please contact your local distributor or an Air Sniper representative directly for a replacement. The Induct BAS compatible unit is designed as a complete unit, therefore when the lamp expires, the entire unit must be replaced.



TROUBLESHOOTING

If your unit is not operating as expected, there are several steps you can take to attempt to correct the problem.

If the “**Lamp Operating**” LED is not illuminating after powering on:

- Inspect the unit and the power connections to verify nothing appears damaged.
- Check that the selected power source is in fact providing power to the unit.
- Once airflow is established, the lamp indicator light will be lit.
- Check that both ends of the power connections are correctly wired and securely connected to the unit and the power source.

WARNING: Do not attempt to operate the UVC lamp outside of the unit enclosure. UVC radiation is extremely harmful to unprotected skin and eyes

ADDITIONAL FACTORS

given that air pressure can change at differing elevations and differing humidity levels, for safety reasons the lamp requires a minimum value of airflow to ensure safety.

If the “**Lamp Operating**” LED is not illuminated and you’ve verified a correct setup and proper installation. Try increasing the airflow if possible and verify the airflow of the HVAC system matches with the orientation of the unit.

If the “**Lamp Operating**” LED is not able to illuminate at any airflow and troubleshooting didn’t solve the issue.
Please contact your Air Sniper representative at **1.888.338.9549** or email us at info@airsniper.ca



REPLACING YOUR UNIT

The Induct BAS compatible unit uses a built in 300w UVC lamp with a lifetime of 6+ years (55,200 hours, based on 24/7 operation).

To track the life of the lamp on your unit, check the “**Lamp Operating**” LED color when the unit is powered on to determine the state of your unit. It is strongly recommended that the unit be replaced when the “**Lamp Life Warning**” **yellow** LED is illuminated.

When the lamp life has been exceeded, the LED will glow red. The entire unit will need to be replaced. Contact your local distributor or Air Sniper representative to order replacements.

REPLACEMENT

WARNING: UV-C lamps generate heat during operation, allow 20-30 minutes after unplugging the unit for the lamp to cool down.

1. Disconnect the expired unit from the power source.
2. Locate and remove the (12) - #8 Tek screws used to install the unit and carefully remove the unit from the duct.
3. Insert a new Induct BAS compatible unit into the duct. ([Refer to Installation on page 8](#)).
4. Place and tighten the (12) - #8 Tek screws back into place, securing the unit into the duct.
5. Connect and wire the power cord to the newly installed unit.
6. Once connected and powered on, the “**Lamp Operating**” LED will be illuminated.
7. Once the new unit is installed, carefully package the old unit with all included equipment to ship to your local distributor or directly to Air Sniper for store credit.



WARRANTY

We take pride in the quality of our products. In the case of a defective piece of equipment, AIR Alpine Innovative Research Inc. offers a limited five-year warranty on all our products (excluding bulbs). In case of a discovered defect, we will replace or repair the unit. Extended Warranty is available.

Line conditioner required to prevent damage. To prevent damage and ensure warranty coverage please ensure line conditioners are on all AC inputs to protect equipment from voltage spikes. If a line conditioner is not installed your Warranty may not be valid.

Please see below for recommended line conditioner specifications. Line conditioners can be purchased online or through a local building supply store.

Limited Warranty Five Year Warranty

Alpine Innovative Research Inc. (AIR) warrants the Air Sniper™ unit to be free from defects in the workmanship or materials under normal use and service (the “Warranty”) for a period of Five (5) years (the “Warranty Period”) from the date of purchase through an AIR-authorized dealer/distributor. During the Warranty Period, should an Air Sniper™ unit be determined to be defective, AIR shall repair or replace the defective Air Sniper™ unit(s) (at AIR or dealer’s option) within a reasonable period.

Remedy Procedures

If the Air Sniper™ unit proves defective within the Warranty Period, the purchaser may choose one of the following remedies, after contacting AIR for a Return Authorization Number:

1. Return the defective Air Sniper™ unit to the dealer/distributor from whom it was purchased together with a copy of the bill of sale or dated proof of purchase thereof and the Return Authorization Number; or
2. Ship the defective Air Sniper™ unit directly to Air Alpine Innovative Research Customer Warranty Department along with the Return Authorization Number.

Limitations

This Warranty is the only representation regarding the Air Sniper™ unit, by Alpine Innovative Research Inc. of merchantability and fitness for use and shall extend to five (5) years from the date of purchase. The warranty excludes replaceable UVC bulbs. If it is determined by either Alpine Innovative Research Inc. or an authorized dealer/distributor that the defect is the result of damage caused by the purchaser, the Warranty is null and void.

Contact us with any questions, comments or concerns pertaining to this warranty at Air Sniper by e-mail, telephone, or in-person at AIR, Alpine Innovative Research.

Customer Warranty Department

(Toll Free): 1.888.338.9549

info@airsniper.ca

Air Sniper

11-6565 40th Street S.E.

Calgary, AB Canada T2C 2J9