

Air Sniper Induct 300W Standard

Instruction Manual





A WORD TO AIR SNIPER OWNERS

At Air Sniper, we design and build air supplemental sanitization systems with complete customer satisfaction in mind. To ensure trouble-free operation of your supplemental air sanitization system, please read this manual and follow installation recommendations.

An authorized Air Sniper representative will know the system best, and if service or maintenance is needed, the Air Sniper team is here to help. Our team provides you with the best possible service and ensuring your satisfaction with our product.

For inquiries, questions or concerns regarding the unit, or any other Air Sniper products contact:



1.866.472.1059

info@airsniper.ca

Air Sniper Bay 11

6565 40th Street S.E.

Calgary, AB Canada T2C 2J9

Call, email or fill out the online form and one of our customer service specialists will get in touch with you.

© AIR ALPINE INNOVATIVE RESEARCH INC. All rights reserved. This document is subject to change without notice.

All Air Sniper trademarks and logos are owned by Air Sniper or one of its affiliates. Unless expressly noted, names and brands of third parties that may be used in this document are not used to indicate an affiliation or endorsement between the owners of these names and brands and AIR ALPINE INNOVATIVE RESEARCH INC. Those names and brands may be the trademarks or registered trademarks of those third parties. Because we are continuously improving our products and services, Air Sniper reserves the right to change specifications without prior notice. Air Sniper is an equal opportunity employer.



IMPORTANT SAFETY INSTRUCTIONS

WARNING: NEVER EXPOSE SKIN OR EYES TO UV LAMP WHEN OPERATING

Read and follow all instructions prior to installation. Read the directions and all safety labels prior to operation. Failure to follow any instructions or labels may result in injury of the user or damage to the unit. Save this manual for future reference.

1. The Induct 300W unit is intended to be used for supplemental air sanitization inside of a sealed air chamber. **Do not** attempt to operate the UV-C lamps outside of the sealed housing.
2. Electrical shock may cause Injury or possible death. Ensure that the unit is turned off and disconnected from the power source prior to installation or replacement.
3. Untrained personnel can perform installation and replacement of the unit as per the instructions within this manual. **Do not** attempt to perform any maintenance on your unit. Improper maintenance can result in damage to the unit and injury of the user. If your unit requires maintenance, please contact Air Sniper. Replacement of the UV-C lamp by the user is **not allowed**.
4. **Do not** attempt to modify your unit. Modification of this unit may result in injuries to the user or damage to the unit.
5. Inspect your unit for any abnormalities or damage prior to installation and use. Damaged units can result in harmful UV-C leaks. **Do not** operate units that are damaged.
6. If the supply cord is damaged, it must be replaced by the manufacturer, a service agent or similarly qualified persons in order to avoid a hazard.
7. This appliance contains a UV-C emitter. UV-C lamps contain small amounts of mercury. If the lamp is broken or damaged, clean and dispose of it properly as per your local safety regulations.
8. The Induct 300W unit unit is not to be used by persons (including children) with reduced physical, sensory or mental capabilities, or a lack of experience and knowledge, unless properly supervised. Children shall be supervised so that they do not to play with the unit.
9. It is recommended a minimum of 2 people are present when installing the unit. Units can be heavy and require care and precision when installing.
10. Air Sniper products are not waterproof. **Do not** attempt to use your unit in a wet environment.
11. Air Sniper products are designed for indoor use only. **Do not** attempt to install your unit outdoors.
12. The use of this device is a supplement to and not a substitute for standard infection control practices; users must continue to follow all current infection control practices related to cleaning and disinfection of environmental surfaces.
13. The Induct 300W unit does not require cleaning to continue to operate effectively.
14. **FIRST AID INSTRUCTIONS:** If Injury occurs, contact your doctor or appropriate emergency services.
15. **WARNING: UV RADIATION EMITTED FROM THIS DEVICE.** Unintended use of the appliance or damage to the housing may result in the escape of dangerous UV-C radiation. UV-C radiation may, even in small doses, cause harm to the skin and eyes

RECOMMENDED LINE CONDITIONER SPECIFICATIONS



Line conditioner required to prevent damage. To prevent damage and ensure warranty coverage please ensure line conditioners are on all AC inputs to protect equipment from voltage spikes. If a line conditioner is not installed your Warranty may not be valid.

Please see below for recommended line conditioner specifications. Line conditioners can be purchased online or through a local building supply store.

Surge Protection Device - Surge Protective Device, 3-Mode, 120/240 VAC 1Ph, Type 1 or Type 2, Outdoor, Connected Equipment Warranty 3yr \$7,500

Item AG3000



PRODUCT DESCRIPTION

Power surges are the silent killer for home appliances and HVAC equipment. Most homeowners protect their electronics, but leave more valued equipment unprotected. Surges can wipe out equipment and leave you searching for answers. Search no more. The easy-to-install AG3000 Surge Protective Device (SPD) is the perfect add-on for HVAC equipment. A green LED indicator provides the status of protection. Trusted, state-of-the-art TPMOV® (Thermally Protected Metal Oxide Varistor) technology eliminates the potentially hazardous failure modes that are commonly associated with standard MOV technology. UL Listed to ANSI/UL 1449, 4th Edition.

FEATURES

- ▶ Three modes of protection: L-G, L-L, L-N
- ▶ TPMOV® surge protection technology
- ▶ Green LED indicator provides status of protection
- ▶ Type 4X watertight and UV resistant plastic enclosure
- ▶ 3-year product warranty
- ▶ \$7,500 connected equipment warranty for 3 years
- ▶ UL Listed to ANSI/UL 1449 5th edition

APPLICATIONS

- ▶ Distribution Panel
- ▶ Service Entrance
- ▶ HVAC Equipment Protection

TECHNICAL DATA

General	
Model Number	AG3000
Description	Surge Protective Device, 3-Mode, 120/240 VAC 1Ph, Type 1 or Type 2, Outdoor, Connected Equipment Warranty 3yr \$7,500
UPC Code	078275130678
Brand	Intermatic
Country of Origin (Intermatic)	MEXICO
Warranty Period	3-Year limited
Connected Equipment Warranty Period	3-Year limited
Connected Equipment Warranty Coverage (USD)	7500

Electrical Specifications

Modes of Protection	3 (L1-N, L2-N, L1-L2)
---------------------	-----------------------



Electrical Specifications

Modes of Protection	3 (L1-N, L2-N, L1-L2)
Short Circuit Current Rating	100 kA
Nominal Discharge Current	20 kA
Maximum Surge Current Rating Per Phase	50 kA
Surge Protection Technology	TPMOV®
Maximum Continuous Operating Voltage (L-G)	150
Maximum Continuous Operating Voltage (L-L)	300
Maximum Continuous Operating Voltage (L1-N/G)	150
Voltage Protection Rating (L-L)	1200
Voltage Protection Rating (L1-N/G)	700
Phase	Single

Control Specifications

Undervoltage Pickup [120 VAC] (VAC)	104
Undervoltage Pickup [208 VAC] (VAC)	180
Undervoltage Pickup [240 VAC] (VAC)	208
Surge Protection Type	1; 2
Surge Protection LED Indicator	Green

Mechanical Specifications

Number of Wire Leads	3
Enclosure Type	Indoor/outdoor type 4X

Dimensions

Product Dimensions (H x W x D) in	3.875 x 1.625 x 4.188 in
Wire Lead Length (in)	18
Wire Size Max	#10 AWG, Tinned Copper

Air Sniper Induct 300W Standard



FEATURES

No Ozone (UL 2998 Certified, CARB Certified)

6+ Year Lamp Life (55, 200 Hours)

Plug & Play

300 Watt Bulb

SPECIFICATIONS

Available Power Requirements:	Single Phase, 110V AC 50/60 Hz, or 208-240 VAC, Single Phase, 60 Hz
Energy Consumption:	3.5 Amp Max (420 Watt) @110V AC ,1.8 Amp Max @208V AC
Weight:	15 lbs (7 kg)
Power Control:	On/Off Switch
Housing Material:	Aluminum
Dimensions:	25" (H) x 10" (W) x 5.36" (D)
Electrical Safety Certification:	cETLus Certified, UL and CSA Standards
Airflow Detection:	Differential Pressure Switch
Operating Temp Range:	-20C/+100C
Recommended Airflow:	500-7,500 CFM
Status Indicator:	Status/lamp life indicator





DETAIL DRAWINGS

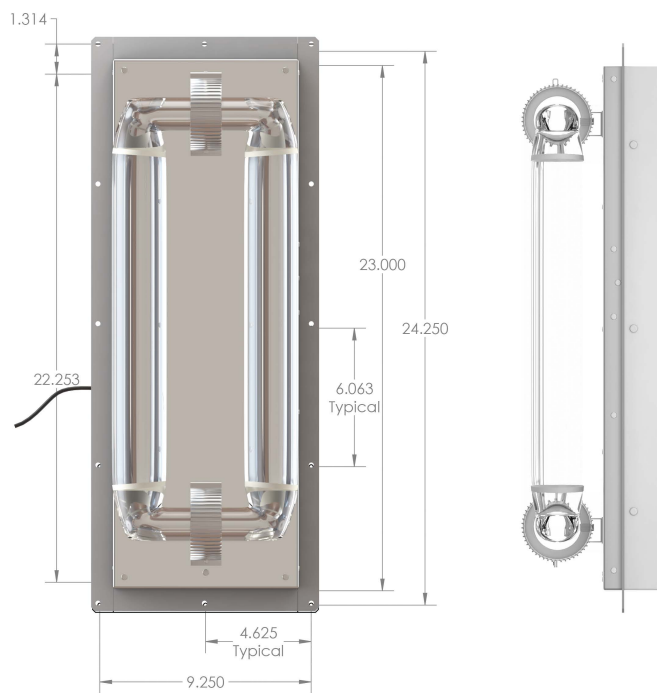



ABOUT YOUR UNIT

For more information on the Induct 300W unit and all other Air Sniper products and services, call (Toll Free) **1-888-338-9549**, visit www.airsniper.ca or email Air Sniper at info@airsniper.ca with any questions, comments or concerns.

DESIGN

The Induct 300W unit is made up of several key components listed below.

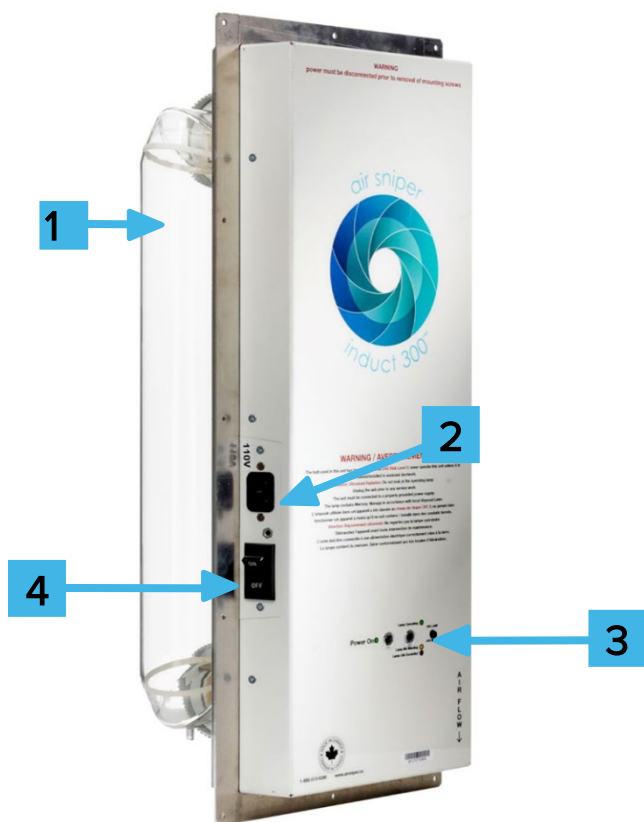

1. 300W UVC Lamp
2. Power Port
3. Power and lamp indicators
4. On/Off Switch



FEATURES

- 300 Watt UV-C Induction Lamp
- 6+ Year Lamp Life (55,200 Hours)
- UL 2998 Certified
- No maintenance
- Canadian Made

SPECIFICATIONS

Power Supply

Single Phase, 110V A/C 50/60 Hz
Or
Single Phase, 208V – 240V A/C 50/60 Hz

Energy Consumption

1.8 Amp Max @ 208v A/C

Operating Temperature Range

-25°C / 100°C

Power Control Systems

On/Off Switch,
15-30v AC / 10-120v AC

Bulb Life

55,200 hours (6+ years) of high intensity
UVC.

Electrical Safety Certification

cETLus Certified, UL & CSA Standards

Ozone Certification

UL2998 certified.

Weight

15 lbs (7.0 kg)

Dimensions

25" (H) x 10" (W) x 5.36" (D)

Housing Material

Aluminum



INCLUDED PARTS

Included in the package you will find:

1. Induct 300W standard
2. Power Connection Cord
3. 4 x Magnetic Lined Reflective Panels (22 ¾" x 8" each)
4. (12) - #8 Tek Screws





INSTALLING YOUR UNIT

CAUTION: Use care when unboxing and handling your unit. Ensure adequate space is available for unboxing, installation, and operation prior to attempting to handle your unit. Ensure that the intended placement of your unit allows access to the necessary power requirements and does not create a hazard once connected.

REQUIRED TOOLS

- Drill for Tek screws
- Drill bit to initiate cut-out puncture.
- Sheet metal tin snips or appropriate cutting equipment
- (12) - #8 Tek screws

INSTALLATION

To Install the Induct 300W unit:

1. Remove from packaging

- a. Carefully remove your Induct 300W unit, Power Port Connection Cord, (12) - #8 Tek screws and reflective panels from the shipping box.
- b. Inspect the unit and all components, make note of any damage or defects that may have occurred during shipment.

If after opening your unit you notice any missing or damaged components, please contact your Air Sniper representative for immediate assistance.

(Toll Free) 1.888.338.9549

www.airsniper.ca



2. Prepare location for installation

- c. Determine the best location to install your unit. Both return and supply duct locations are acceptable for installation. Return air installation can assist with coil cleaning. For more information on best locations for your unit, consult the installation parameters in this manual or contact Air Sniper.
- d. Once an installation location has been determined, take note of the direction of airflow within the duct. In order to maximize effectiveness, make sure to mount the unit accordingly.



- e. Turn off all HVAC equipment prior to installation. Ensure that all exterior insulation of the HVAC duct is cut 2" back from the point of installation.
- f. Using one of the included reflective panels as a template, identify and mark the intended cut out location for mounting the unit and trace the panel where the unit will be installed. Traced rectangle should have the following dimensions: 22 3/4" x 8"





4. Cutting into the duct

- a. Drill a hole on one of the corners of your traced outline using it as a starting point to cut out the opening in the duct for the unit to be installed. Ensure that the drill hole is made within the perimeter traced as to not leave a gap once the unit is installed.

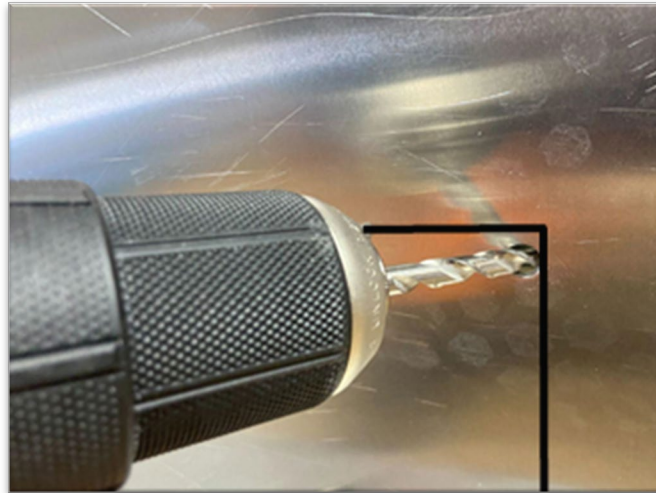

- b. Using the sheet metal snips (or other appropriate cutting device), carefully follow the trace, slowly cutting the opening where the unit is to be installed.





3. Placing reflective panels

- a. Remove blue protective plastic film from the provided magnetic reflective panels



- b. Carefully place the unit through the cut-out in the duct work
- c. Using your drill, the (12) #8 Tek screws and the pre-drilled mounting holes, secure the unit into the pre-cut duct work
- d. **Due to the thickness of ducts or imperfections foil HVAC tape may be required to prevent light leakage on the cut lines.**



Reminder: When mounting, it is strongly recommended to consider a scheme that allows easy access for maintenance and unit replacement.



DIRECTIONS FOR USE

To Operate your Induct 300 unit,

1. Connect the supplied 10' power cable to the unit.



2. Locate the nearest appropriate receptacle. If required an extension cable can be used to extend the distance from the power receptacle. Proceed to plug in the unit.





3. Confirming the power is properly connected, turn the unit **on** using the on/off switch located on the right side of the white front panel.



4. Once power is detected, the “**Lamp Operating**” LED will illuminate, indicating the UVC Lamp is on.

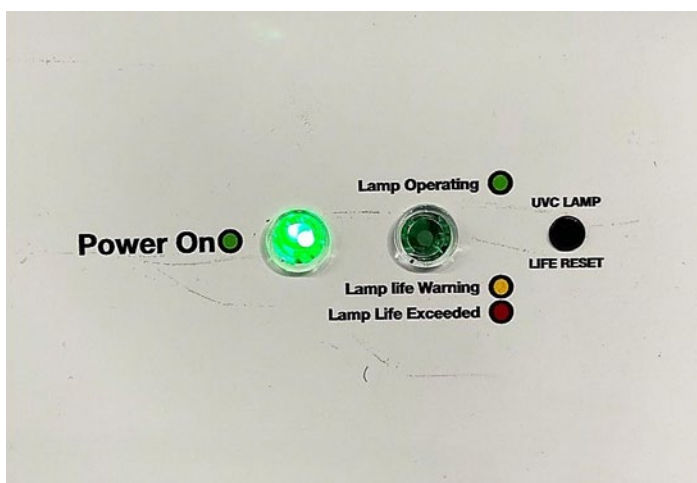



- a. If all the connections are correct and the outlet is tested to verify the unit is receiving power but the “Power On” LED still isn’t illuminated, turn your unit off and contact an Air Sniper representative.

BULB STATUS



The “Lamp Operating” LED can illuminate three different colors, indicating differing bulb status.

The variations are as follows:

	Green: Lamp operating, the lamp is operating as intended.
	Yellow: Lamp life warning, the lamp is nearing the end of its lifespan, requires replacement in the near future.
	Red: Lamp life exceeded, lamp has reached the end of its lifespan, requires immediate replacement.

When the “Lamp Operating” LED color is **yellow** indicating “Lamp Life Warning” please contact your local distributor or an Air Sniper representative directly for a replacement. The Induct 300W unit is designed as a complete unit, therefore when the lamp expires, the entire unit must be replaced.



TROUBLESHOOTING

If your unit is not operating as expected, there are several steps you can take to attempt to correct the problem.

If the “**Lamp Operating**” LED is not illuminating after powering on:

- Inspect the unit and the power connections to verify nothing appears damaged.
- Check that the selected power source is in fact providing power to the unit.
- Once airflow is established, the lamp indicator light will be lit.
- Check that both ends of the power connections are correctly wired and securely connected to the unit and the power source.

WARNING: Do not attempt to operate the UVC lamp outside of the unit enclosure. UVC radiation is extremely harmful to unprotected skin and eyes

ADDITIONAL FACTORS

given that air pressure can change at differing elevations and differing humidity levels, for safety reasons the lamp requires a minimum value of airflow to ensure safety.

If the “**Lamp Operating**” LED is not illuminated and you’ve verified a correct setup and proper installation. Try increasing the airflow if possible and verify the airflow of the HVAC system matches with the orientation of the unit.

If the “**Lamp Operating**” LED is not able to illuminate at any airflow and troubleshooting didn’t solve the issue. Please contact your Air Sniper representative at **1.888.338.9549** or email us at info@airsniper.ca



REPLACING YOUR UNIT

The Induct 300W unit uses a built in 300W UVC lamp with a lifetime of 6+ years (55,200 hours, based on 24/7 operation).

To track the life of the lamp on your unit, check the “**Lamp Operating**” LED color when the unit is powered on to determine the state of your unit. It is strongly recommended that the unit be replaced when the “**Lamp Life Warning**” **yellow** LED is illuminated.

When the lamp life has been exceeded, the LED will glow red. The entire unit will need to be replaced. Contact your local distributor or Air Sniper representative to order replacements.

REPLACEMENT

WARNING: UV-C lamps generate heat during operation, allow 20-30 minutes after unplugging the unit for the lamp to cool down.

1. Disconnect the expired unit from the power source.
2. Locate and remove the (12) - #8 Tek screws used to install the unit and carefully remove the unit from the duct.
3. Insert a new Induct 300W unit into the duct. ([Refer to Installation on page 8](#)).
4. Place and tighten the (12) - #8 Tek screws back into place, securing the unit into the duct.
5. Connect and wire the power cord to the newly installed unit.
6. Once connected and powered on, the “**Lamp Operating**” LED will be illuminated.
7. Once the new unit is installed, carefully package the old unit with all included equipment to ship to your local distributor or directly to Air Sniper for store credit.



WARRANTY

We take pride in the quality of our products. In the case of a defective piece of equipment, AIR Alpine Innovative Research Inc. offers a limited five-year warranty on all our products (excluding bulbs). In case of a discovered defect, we will replace or repair the unit. Extended Warranty is available.

Line conditioner required to prevent damage. To prevent damage and ensure warranty coverage please ensure line conditioners are on all AC inputs to protect equipment from voltage spikes. If a line conditioner is not installed your Warranty may not be valid.

Please see below for recommended line conditioner specifications. Line conditioners can be purchased online or through a local building supply store.

Limited Warranty Five Year Warranty

Alpine Innovative Research Inc. (AIR) warrants the Air Sniper™ unit to be free from defects in the workmanship or materials under normal use and service (the “Warranty”) for a period of three (5) years (the “Warranty Period”) from the date of purchase through an AIR-authorized dealer/distributor. During the Warranty Period, should an Air Sniper™ unit be determined to be defective, AIR shall repair or replace the defective Air Sniper™ unit(s) (at AIR or dealer’s option) within a reasonable period.

Remedy Procedures

If the Air Sniper™ unit proves defective within the Warranty Period, the purchaser may choose one of the following remedies, after contacting AIR for a Return Authorization Number:

1. Return the defective Air Sniper™ unit to the dealer/distributor from whom it was purchased together with a copy of the bill of sale or dated proof of purchase thereof and the Return Authorization Number; or
2. Ship the defective Air Sniper™ unit directly to Air Alpine Innovative Research Customer Warranty Department along with the Return Authorization Number.

Limitations

This Warranty is the only representation regarding the Air Sniper™ unit, by Alpine Innovative Research Inc. of merchantability and fitness for use and shall extend to five (5) years from the date of purchase. The warranty excludes replaceable UVC bulbs. If it is determined by either Alpine Innovative Research Inc. or an authorized dealer/distributor that the defect is the result of damage caused by the purchaser, the Warranty is null and void.

Contact us with any questions, comments or concerns pertaining to this warranty at Air Sniper by e-mail, telephone, or in-person at AIR, Alpine Innovative Research.

Customer Warranty Department

(Toll Free): 1.888.338.9549

info@airsniper.ca

Air Sniper

11-6565 40th Street S.E.

Calgary, AB Canada T2C 2J9